



The craft projects and works featured in kokka-fabric.com are strictly for personal use and enjoyment.
Please refrain from selling handmade items using the same exact design (including the pieces made in different fabrics) featured in kokka-fabric.com.

Collage Bag

Design: Ayumi Toda (fabrica uka)

Work: Kokka Fabric

Size: 40cm (l) 50cm (w)

Materials

- Fabric (Outer fabric Side A a):30cm×50cm
 - Fabric (Outer fabric Side A b):30cm×50cm
 - Fabric (Outer fabric Side A c):20cm×50cm
 - Fabric (Outer fabric Side B a):60cm×30cm
 - Fabric (Outer fabric Side B b):40cm×30cm
 - Fabric (Outer fabric Side B c):30cm×40cm
 - (Lining fabric, Pocket):80cm×90cm
 - (Handle Side A):10cm×40cm
 - (Handle Side B):10cm×40cm
 - Fusible interfacing:10cm×40cm
- Fabric shown for this sample
- Fabric (Outer fabric Side A a): tayoutou step JG50800-804B
 - Fabric (Outer fabric Side A b): tayoutou JG50810-10E
 - Fabric (Outer fabric Side A c): tayoutou root crop JG50800-800C
 - Fabric (Outer fabric Side B a): tayoutou root crop JG50800-800B
 - Fabric (Outer fabric Side B b): tayoutou JG50810-10A
 - Fabric (Outer fabric Side B c): tayoutou fujisan JG50800-803A
 - (Handle Side A): tayoutou JG50810-10F
 - (Handle Side B): tayoutou JG50810-10C

Pattern

All measurements are in centimeters (cm).
Numbers in () denote seam allowance. Add 1cm seam unless specified otherwise.

Outer fabric Side A

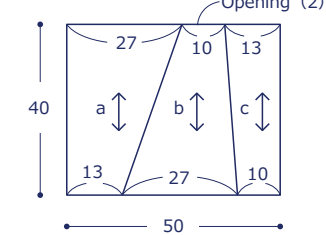

Outer fabric Side B

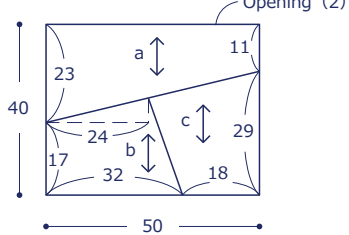

Lining Fabric

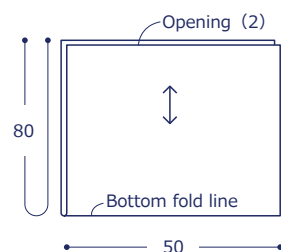

Pocket

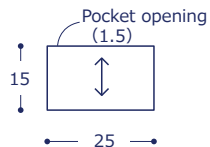

Handle Side A · Side B

Two each

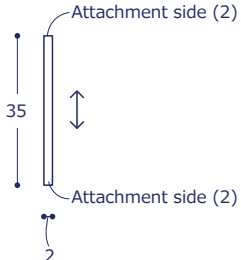

Instructions

1. Make the outer fabric.

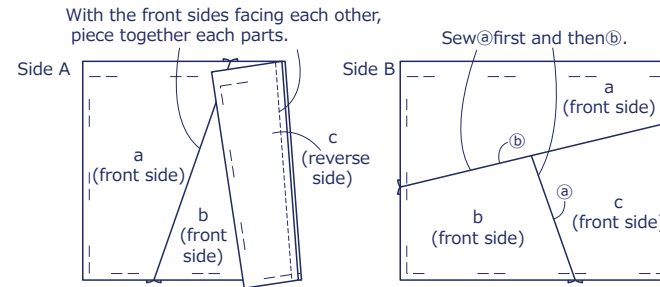

3. Make the lining bag.

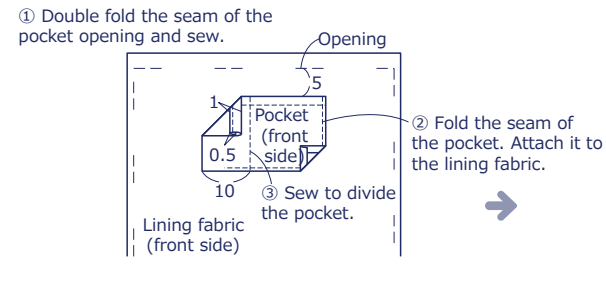

2. Make the outer bag.

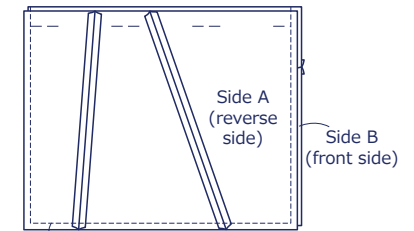

With the front sides facing each other, sew together the Side A and B on the sides and bottom.

④ With the front sides facing each other, fold the lining fabric in half and sew the sides (leaving an opening for turning on one side).

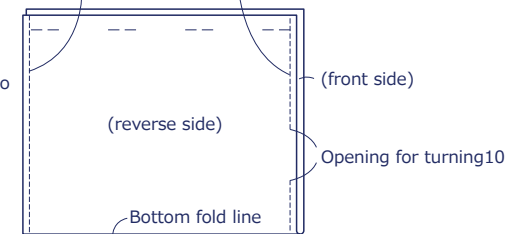

4. Make the handles.

① Adhere fusible interfacing on the back of the Handle Side A.

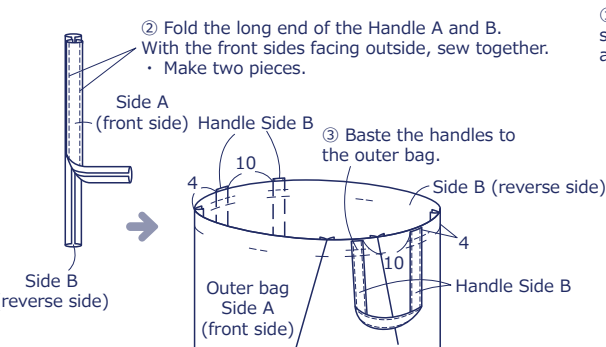

5. Finish the bag.

